

VFS250i Specifications



FEATURES

- High output sub bass system
- Dual 15-in cone transducers
- Optimally vented for increased response
- Extended pole mount cup creates stable base
- Easy lift handles (Black version only)

DESCRIPTION

The VFS "i" revision brings the VF concept more fully into the EAW product line. VFS "i" Series black versions use handles from the KF and JF Series. An installation only white version comes without handles or a pole mount cup.

The VFS250i sub bass system includes dual, direct radiating 15-in LF cone transducers mounted in an optimally vented enclosure. Enclosure venting uses the enclosure's resonance to enhance LF response while limiting driver wear.

The VFS250i black version includes traditional portable features such as a pole-mount cup, parallel NL4 4-terminal connectors, barrier strip inputs, and handles that accept accessory covers for permanent installation. The white, installation-only versions omit handles and the pole-mount cup but include NL4 connectors, barrier strip inputs, and multiple mounting points. The new design leaves the enclosure sides completely smooth and attractive. Optional rigging hardware is available for preconfigured arrays of VFR and VFS systems.

Six year warranty.

DOUBLE 15-INCH SUBWOOFER

See *NOTES TABULAR DATA* for details

CONFIGURATION

Subsystem:

Transducer	Loading
SUB 2x 15 in cone	Vented

Operating Mode:

Amplifier Channels	External Signal Processing
Single-amp LF/LF	DSP w/1-way filter

PERFORMANCE

Operating Range: 30 Hz to 160 Hz

Nominal Beamwidth:

Horz 360°
Vert 360°

Axial Sensitivity (SPL):

LF1/LF2 (whole space) 99 dB	30 Hz to 160 Hz
(half space) 105 dB	30 Hz to 160 Hz

Input Impedance (ohms):

Nominal	Minimum
LF1/LF2 4	3.7 @ 33 Hz

High Pass Filter: High Pass=>30 Hz, 24 dB/octave Butterworth

Accelerated Life Test:

System	
LF1/LF2 60 V	900 W @ 4 ohm

Calculated Axial Output Limit:

Average	Peak
LF1/LF2 (whole space) 128 dB	134 dB
(half space) 134 dB	140 dB

ORDERING DATA

Description	Part Number
EAW VFS250i Dual 15-inch Subwoofer Black	2041017-90
EAW VFS250i Dual 15-inch Subwoofer White	2041032-90

Optional Accessories

EAW Eyebolt/Forged Shoulder (M10)	0029818
EAW SBK-MK53_VFS-VFR159 Flybar Black [FB5VSK]	2038820
EAW ACC CASTER KIT 100 [ACC-CK100]	0032377-90



VFS250i Specifications

ENCLOSURE

Material Hardwood plywood
 Finish Wear resistant textured black paint
 Grille Powder-coated perforated steel

VFS250i BLACK

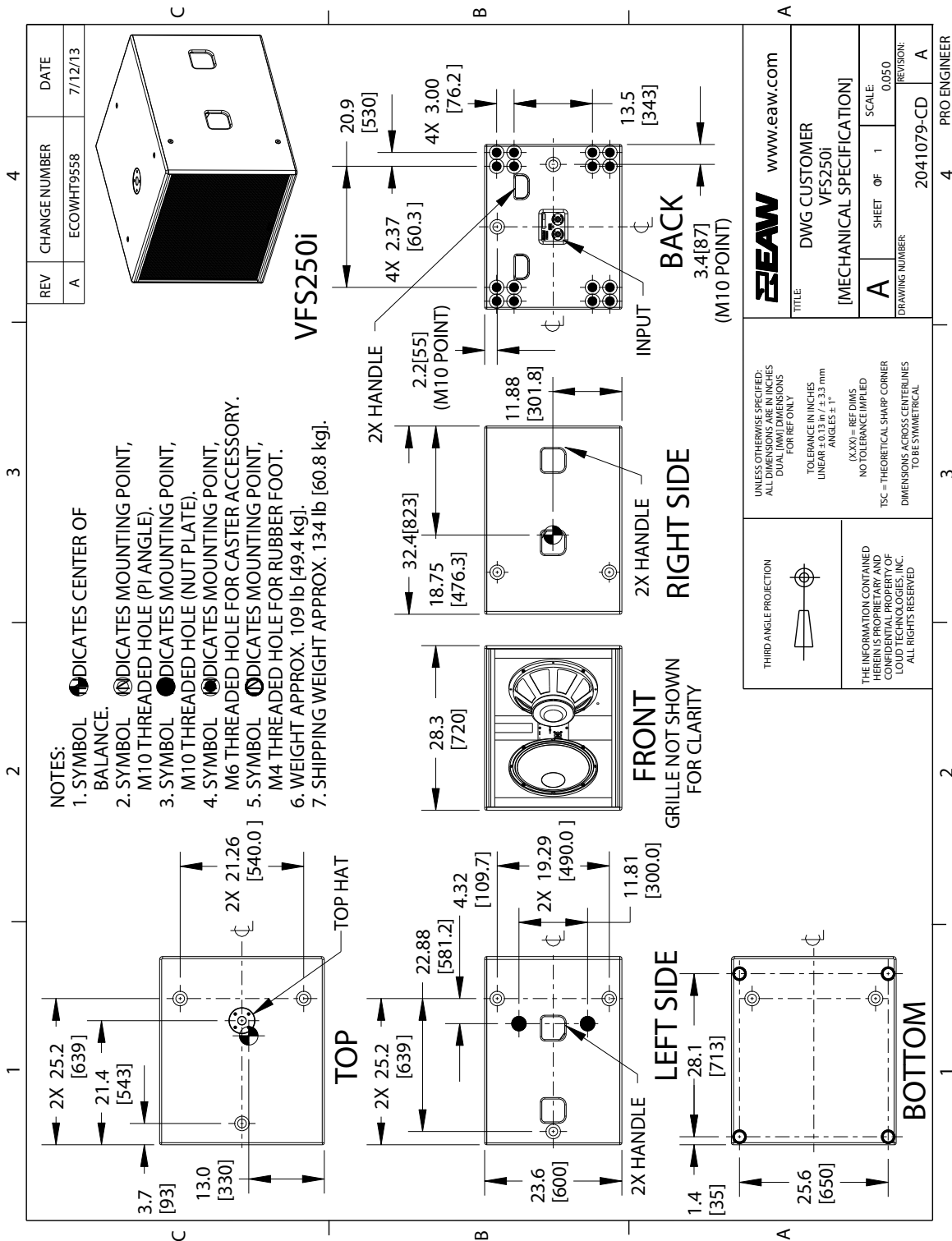

NOTE: This drawing has been reduced. Do not scale.

VFS250i Specifications

ENCLOSURE

Material Hardwood plywood
 Finish Wear resistant textured white paint
 Grille Powder-coated perforated steel

VFS250i WHITE

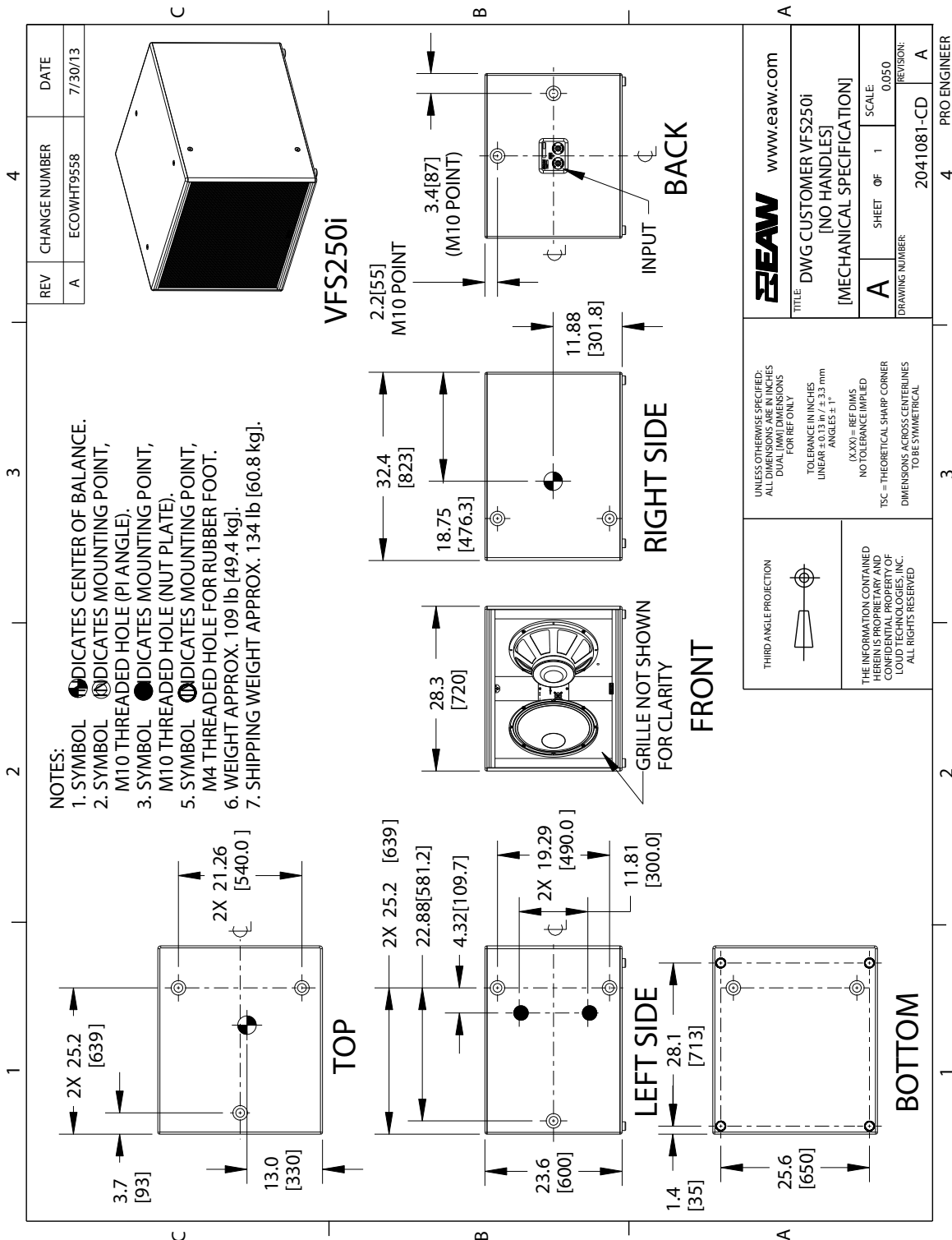

NOTE: This drawing has been reduced. Do not scale.

VFS250i Specifications

PERFORMANCE DATA

See *NOTES GRAPHIC DATA* for details

Frequency Response: Processed

Complete = green

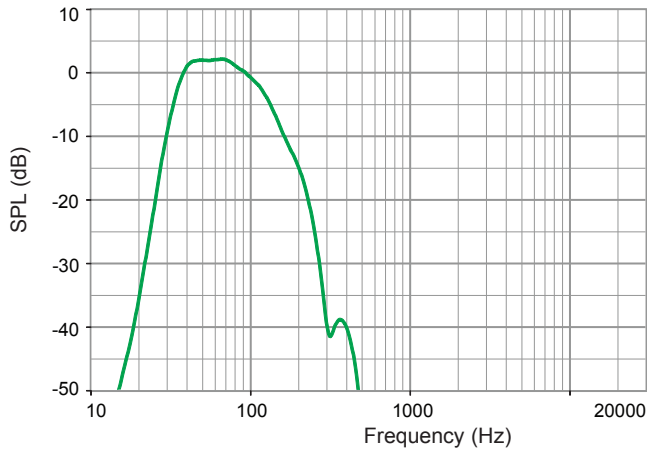

Frequency Response: Unprocessed

Complete = green

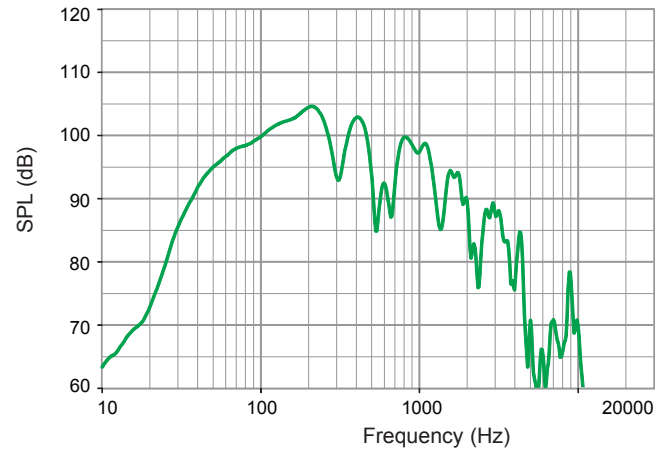

Impedance

Complete = green

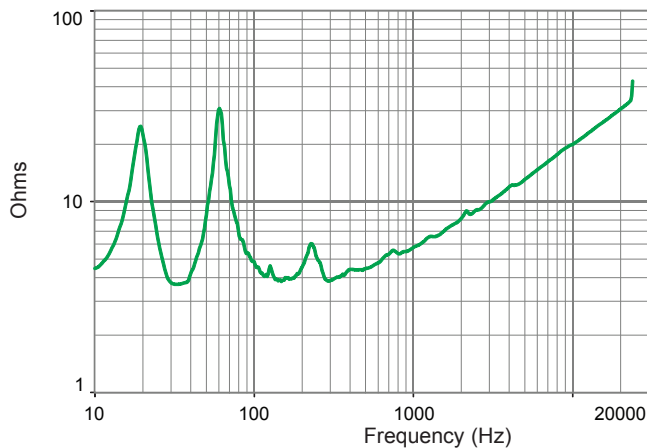

Processor Response

Complete = green

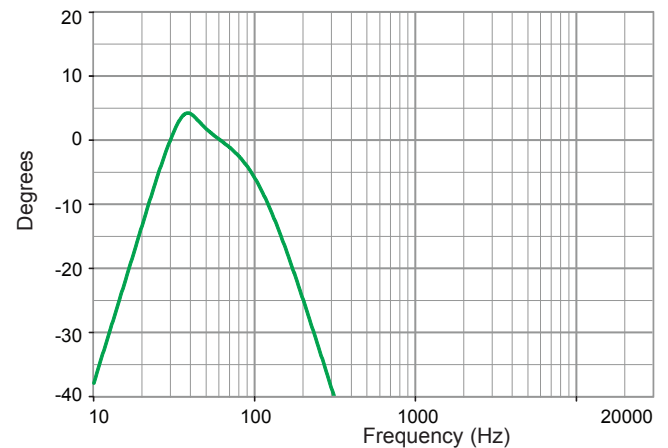

INPUT PANEL

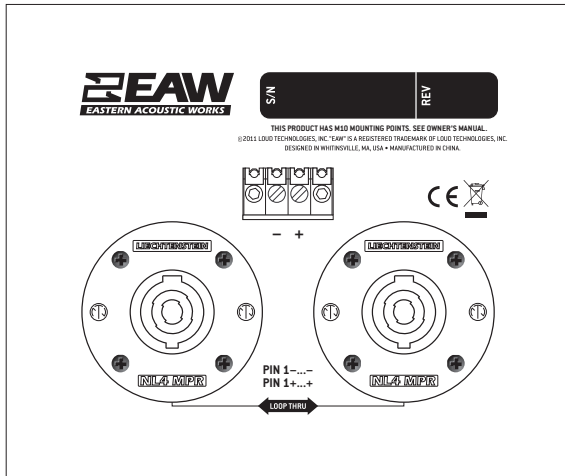

SIGNAL DIAGRAM

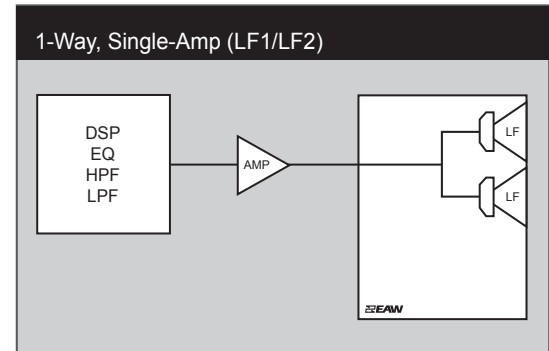

LEGEND

- DSP:** EAW UX8800 Digital Signal Processor –or– Integral Digital Signal Processing for NT products.
- HPF:** High Pass Filter for crossover –or– Recommended High Pass Filter.
- LPF:** Low Pass Filter for crossover.
- LF/MF/HF:** Low Frequency / Mid Frequency / High Frequency.
- AMP:** User Supplied Power Amplifier –or– Integral Amplifier for NT products.
- XVR:** Passive LPFs, HPFs, and EQ integral to the loudspeaker.
- EAW Focusing:** Digital Signal Processor capable of implementing EAW Focusing.

NOTES

TABULAR DATA

1. **Measurement/Data Processing Systems:** Primary - FChart: proprietary EAW software; Secondary - Brüel & Kjær 2012.
2. **Microphone Systems:** Earthworks M30; Brüel & Kjær 4133
3. **Measurements:** Dual channel FFT; length: 32 768 samples; sample rate: 48 kHz; logarithmic sine wave sweep.
4. **Measurement System Qualification** (includes all uncertainties): SPL: accuracy +/-0.2 dB @ 1 kHz, precision +/-0.5 dB 20 Hz to 20 kHz, resolution 0.05 dB; Frequency: accuracy +/-1 %, precision +/-0.1 Hz, resolution the larger of 1.5 Hz or 1/48 octave; Time: accuracy +/-10.4 µs, precision +/-0.5 µs, resolution 10.4 µs; Angular: accuracy +/-1°, precision +/-0.5°, resolution 0.5°.
5. **Environment:** Measurements time-windowed and processed to eliminate room effects, approximating an anechoic environment. Data processed as anechoic or fractional space, as noted.
6. **Measurement Distance:** 7.46 m. Acoustic responses represent complex summation of the subsystems at 20 m. SPL is referenced to other distances using the Inverse Square Law.
7. **Enclosure Orientation:** For beamwidth and polar specifications, as shown in Mechanical Specification drawing.
8. **Volts:** Measured rms value of the test signal.
9. **Watts:** Per audio industry practice, "loudspeaker watts" are calculated as voltage squared divided by rated nominal impedance. Thus, these are not True Watt units of energy as defined by International Standard.
10. **SPL:** (Sound Pressure Level) Equivalent to the average level of a signal referenced to 0 dB SPL = 20 microPascals.
11. **Subsystem:** This lists the transducer(s) and their acoustic loading for each passband. Sub = Subwoofer, LF = Low Frequency, MF = Mid Frequency, HF = High Frequency.
12. **Operating Mode:** User selectable configurations. Between system elements, a comma (,) = separate amplifier channels; a slash (/) = single amplifier channel. DSP = Digital Signal Processor. IMPORTANT: To achieve the specified performance, the listed external signal processing must be used with EAW-provided settings.
13. **Operating Range:** Range where the processed Frequency Response stays within -10 dB SPL of the power averaged SPL within this range; measured on the geometric axis. Narrow band dips are excepted.
14. **Nominal Beamwidth:** Design angle for the -6 dB SPL points, referenced to 0 dB SPL as the highest level.
15. **Axial Sensitivity:** Power averaged SPL over the Operating Range with an input voltage that would produce 1 W at the nominal impedance; measured with no external processing on the geometric axis, referenced to 1 m.
16. **Nominal Impedance:** Selected 4, 8, or 16 ohm resistance such that the minimum impedance point is no more than 20% below this resistance over the Operating Range.
17. **Accelerated Life Test:** Maximum test input voltage applied with an EIA-426B defined spectrum; measured with recommended signal processing and Recommended Protection Filter.
18. **Calculated Axial Output Limit:** Highest average and peak SPLs possible during the Accelerated Life Test. The Peak SPL represents the 2:1 (6 dB) crest factor of the Life Test signal.
19. **High Pass Filter:** This helps protect the loudspeaker from excessive input signal levels at frequencies below the Operating Range.

GRAPHIC DATA

1. **Resolution:** To remove insignificant fine details, 1/12 octave cepstral smoothing was applied to acoustic frequency responses and 1/3 octave cepstral smoothing was applied to the beamwidth and impedance data. Other graphs are plotted using raw data.
2. **Frequency Responses:** Variation in acoustic output level with frequency for a constant input signal. Processed: normalized to 0 dB SPL. Unprocessed inputs: 2 V (4 ohm nominal impedance), 2.83 V (8 ohm nominal impedance), or 4 V (16 ohm nominal impedance) referenced to a distance of 1 m.
3. **Processor Response:** The variation in output level with frequency for a constant input signal of 0.775 V = 0 dB reference.
4. **Beamwidth:** Average angle for each 1/3 octave frequency band where, starting from the rear of the loudspeaker, the output first reaches -6 dB SPL referenced to 0 dB SPL as the highest level. This method means the output may drop below -6 dB SPL within the beamwidth angle.
5. **Impedance:** Variation in impedance magnitude, in ohms, with frequency without regard to voltage/current phase. This means the impedance values may not be used to calculate True Watts (see 9 above).
6. **Polar Data:** Horizontal and vertical polar responses for each 1/3 octave frequency band 100 Hz to 16 kHz or Operating Range.